

Alluminio

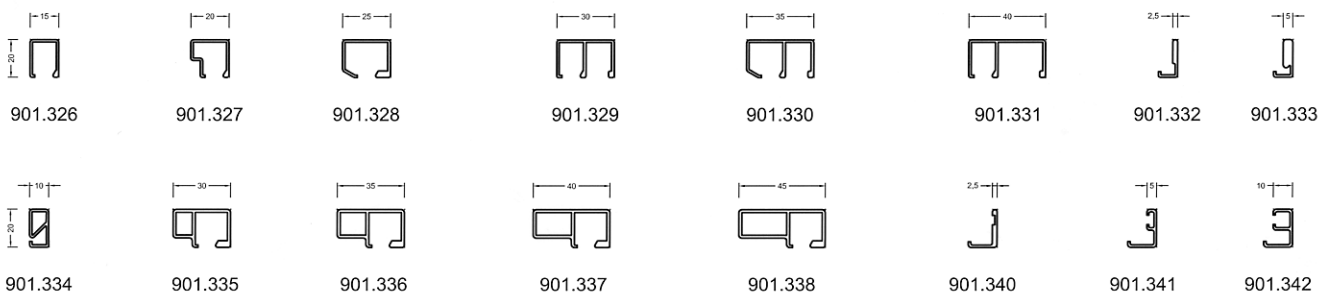

Acciaio Inox

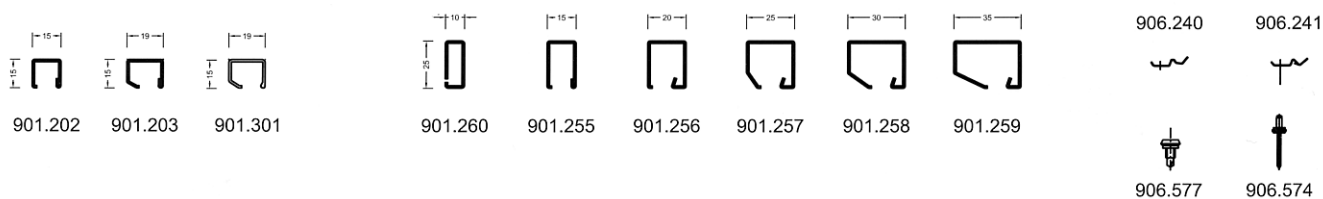
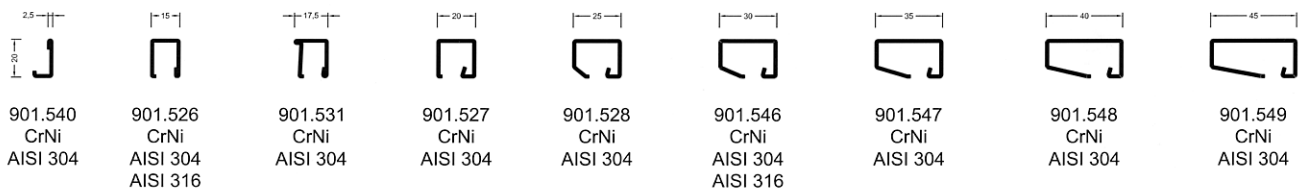

Guarnizioni

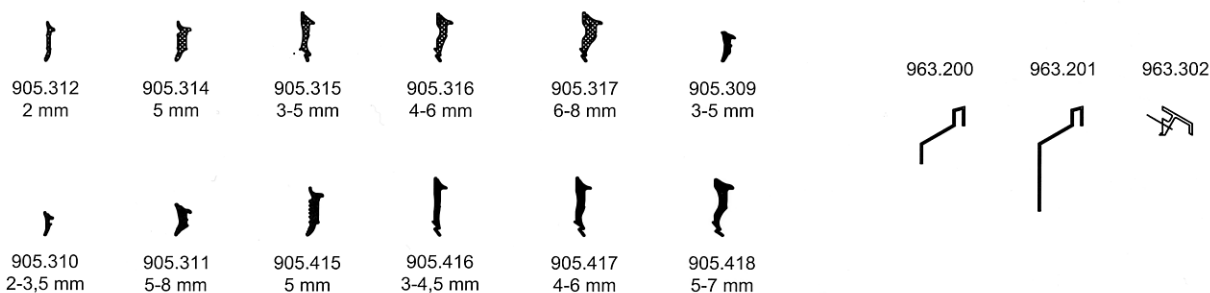

905.306 905.305 925.322 905.200



905.900 905.904 905.905 905.902

903.204



905.201

963.301



900.100

900.103



917.017
917.016 CrNi
917.018

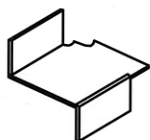

915.600
915.601



916.320 916.322 (50)
916.335 916.336 (60)
916.303 916.304 (60 S)



907.337
907.338

907.335
907.336



907.329

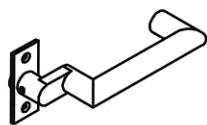

907.326



907.327

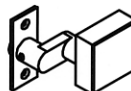

907.328

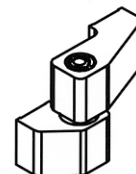

907.317
907.313 CrNi

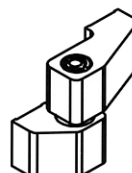
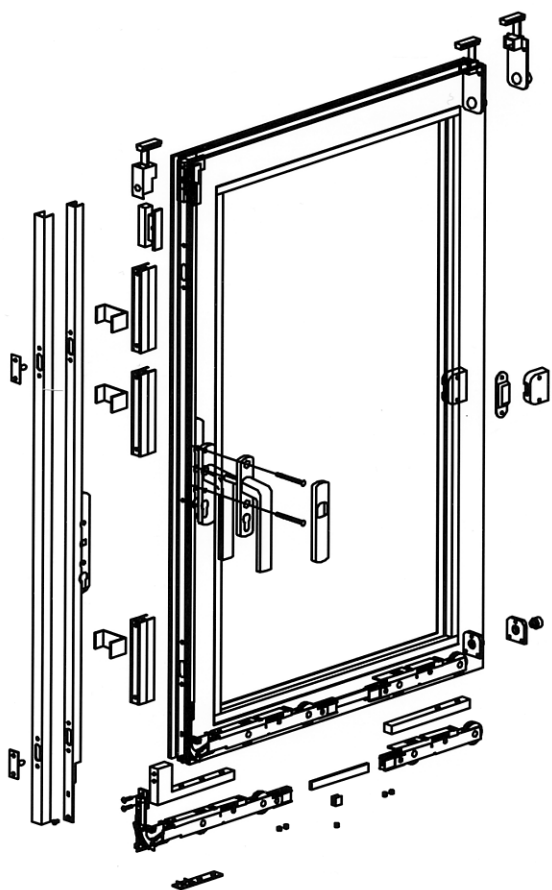

907.326

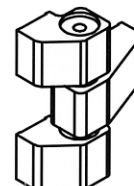

907.316
907.310
907.312 CrNi

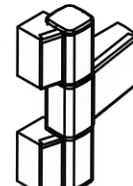

907.632
907.633
907.634
907.636



907.618
907.611 CrNi



907.662
907.664 CrNi



907.667
907.668 CrNi

Autoalzante: 250 / 400 Kg